

# ALLIANCE

OUTDOOR LIGHTING

≡ *Since 2006* ≡



**2022 Product Catalog**



Gio Leonardo, Bella Terra Landscape Design  
bellaterralandscap  
Vincent Bowers  
allianceoutdoorlighting

# THE BT-RE IS REQUIRED AND THERE IS NO SUCH THING AS TOO MANY BT-RE'S!

**The bt-RE range extender is the most important device of a bt system.** Without the bt-RE, you will have trouble setting up and using a bt system. With 70x more signal strength than a bt fixture, the bt-RE increases signal strength and communication between bt fixtures. The 1w bt-RE includes a 10' wire lead that can be wired in just like the bt fixtures, a 5db external antenna and a Bluetooth® module that is housed by solid brass. No matter how many or few fixtures you have installed, the **bt-RE is a must.**

*In this illustration the phone is sending commands to a bt-RE and the bt-RE's are relaying the commands to the other nodes (fixtures) in the mesh network. Note that the orange range extender is installed at higher elevation and has wider coverage while the green range extender is installed at lower elevation and has less coverage.*

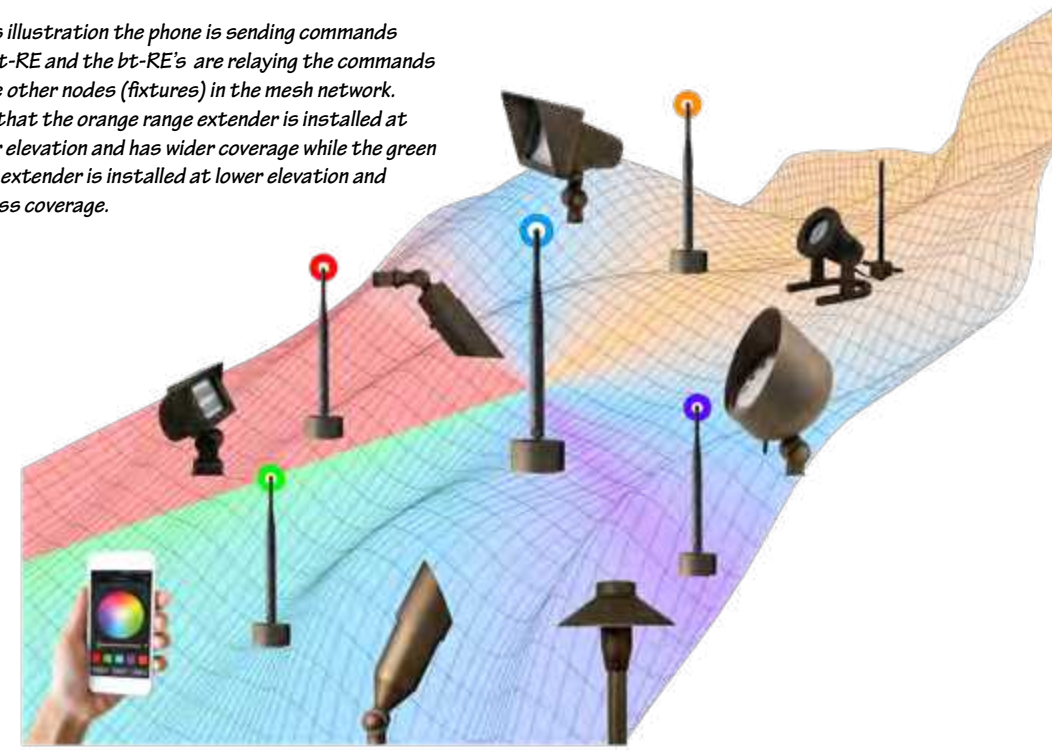

## bt-RE

bt Range Extender

- Cast brass fixture, aged brass finish
- 5 db external antenna
- LED network indicator light
- 10 Foot wire lead, 16 awg (UL listed), brown, pre-connected to the fixture, pre-stripped for easy wire connection
- Plastic ground stake (8.5 in; 21.6 cm length)
- Ten year warranty



## GET YOUR FIXTURES TALKING!

The bt system uses Bluetooth Mesh technology to communicate. The mesh network becomes stronger with more devices in the same network. A distance gap between fixtures can cause a loss of communication. To ensure that all of your fixtures communicate with each other, install a bt Range Extender to each network on every job no matter how big or small.

# Don't install a bt job without them.

# bt family does it all

- CHANGE COLOR TEMPERATURES
- DIM
- GROUP
- CHANGE RGB COLORS
- CREATE CUSTOM SCENES FOR HOLIDAYS AND EVENTS
- CREATE SECURED NETWORKS
- PHONE APP DRIVEN

DOWNLOAD THE BT APP:



App Store



iOS QR Code



Google play





Android QR Code



Visit our online video library to learn more about the bt family of products.  
[www.allianceoutdoorlighting.com/bt-support](http://www.allianceoutdoorlighting.com/bt-support)



 Teserra Outdoors  
 teserra\_outdoors  
 Vincent Bowers  
 allianceoutdoorlighting



**Original bt with improved color range**

## BL200-bt

bt Bullet Light

- Cast brass fixture, aged brass finish
- Cast brass knuckle with dial adjustment
- Fully adjustable brass shroud
- Clear glass convex lens
- Double wire lead pre-connected to the fixture, 16 awg (UL listed), brown
  - 25 foot wire lead, pre-stripped for easy wire connection
  - 18 inch wire lead, LED connection ready
- Plastic ground stake (8.5 in; 21.6 cm length)
- Ten year warranty

Integrated LED Features:

- Wattage: 4-8
- Operating Voltage Range: 10 -14
- Lumen Output: 15 - 350
- Beam Spread: 40°
- CRI: 80
- CCT Options: Preset options for 2700K, 3000K, 4000K
- RGB Options: Unlimited color wheel options with quick preset options
- Dimming: Dimming option available for every color choice
- Scenes: Customizable scene options with up to 3 colors per scene



## FL50-bt

- bt Flood Light
- Cast brass fixture, aged brass finish
- Cast brass knuckle with dial adjustment
- Brass faceplate with rubber gasket
- Clear glass lens
- Double wire lead pre-connected to the fixture, 16 awg (UL listed), brown
  - 25 foot wire lead, pre-stripped for easy wire connection
  - 18 inch wire lead, LED connection ready
- Plastic ground stake (8.5 in; 21.6 cm length)
- Ten year warranty

Integrated LED Features:

- Wattage: 2-5
- Operating Voltage Range: 10 -14
- Lumen Output: 15 - 350
- Beam Spread: 120°
- CRI: 80
- CCT Options: Preset options for 2700K, 3000K, 4000K
- RGB Options: Unlimited color wheel options with quick preset options
- Dimming: Dimming option available for every color choice
- Scenes: Customizable scene options with up to 3 colors per scene



## BL400-bt

- bt Bullet Light
- Cast brass fixture, aged brass finish
- Cast brass knuckle with dial adjustment
- Fully adjustable brass shroud
- Double wire lead pre-connected to the fixture, 16 awg (UL listed), brown
  - 25 foot wire lead, pre-stripped for easy wire connection
  - 18 inch wire lead, LED connection ready
- Brass mounting bracket
- Ten year warranty on integrated fixture

## WL400-bt

- bt Well Light
- ABS Composite Can
- Cast brass debris guard, aged brass finish with a clear glass lens
- Double wire lead pre-connected to the fixture, 16 awg (UL listed), brown
  - 25 foot wire lead, pre-stripped for easy wire connection
  - 18 inch wire lead, LED connection ready
- Ten year warranty on integrated fixture

BL400-bt/WL400-bt Integrated LED Features:

- Wattage: 4-11
- Operating Voltage Range: 10 -14
- Lumen Output: 15 - 900
- Beam Spread: 40°
- CRI: 80
- CCT Options: Preset options for 2700K, 3000K, 4000K
- RGB Options: Unlimited color wheel options with quick preset options
- Dimming: Dimming option available for every color choice
- Scenes: Customizable scene options with up to 3 colors per scene

# 900 LUMEN bt FIXTURES

## FL200-bt

- bt Flood Light
- Cast brass fixture, aged brass finish
- Cast brass knuckle with dial adjustment
- Cast brass faceplate with clear glass lens and optional frosted lens
- Double wire lead pre-connected to the fixture, 16 awg (UL listed), brown
  - 25 foot wire lead, pre-stripped for easy wire connection
  - 18 inch wire lead, LED connection ready
- Ten year warranty on integrated fixture

Integrated LED Features:

- Wattage: 4-11
- Operating Voltage Range: 10 -14
- Lumen Output: 15 - 900
- Beam Spread: 120°
- CRI: 80
- CCT Options: Preset options for 2700K, 3000K, 4000K
- RGB Options: Unlimited color wheel options with quick preset options
- Dimming: Dimming option available for every color choice
- Scenes: Customizable scene options with up to 3 colors per scene

## 900 LUMENS OF LIGHT OUTPUT

The BL400-bt, FL200-bt and WL400-bt (pg 5) are the perfect fixtures for illuminating large or tall areas. The BL400-bt and WL400-bt are uplights that can light up tall trees and structures. The FL200-bt is a flood light with a 120° beam spread for ultimate wall washing ability. 900 lumens with all of the great bt features included makes these fixtures perfect for commercial projects.



## ALSTEM18-bt ALSTEM12-bt

bt Area Light Stem

- Brass stem, aged brass finish
- Brass collar
- Short frosted lens with rubber gasket
- Tall frosted lens with rubber gasket
- Double wire lead pre-connected to the fixture, 16 awg (UL listed), brown
  - 25 foot wire lead, pre-stripped for easy wire connection
  - 18 inch wire lead, LED connection ready
- Plastic ground stake (8.5 in; 21.6 cm length)
- Ten year warranty on integrated fixture

\*Note: Area light hats are sold separately  
Compatible with AL100, AL150, AL250, AL300, AL400, AL500, and AL550

### Integrated LED Features:

- Wattage: 2-6
- Operating Voltage Range: 10 -14
- Lumen Output: 15 - 350
- Beam Spread: 360°
- CRI: 80
- CCT Options: Preset options for 2700K, 3000K, 4000K
- RGB Options: Unlimited color wheel options with quick preset options
- Dimming: Dimming option available for every color choice
- Scenes: Customizable scene options with up to 3 colors per scene

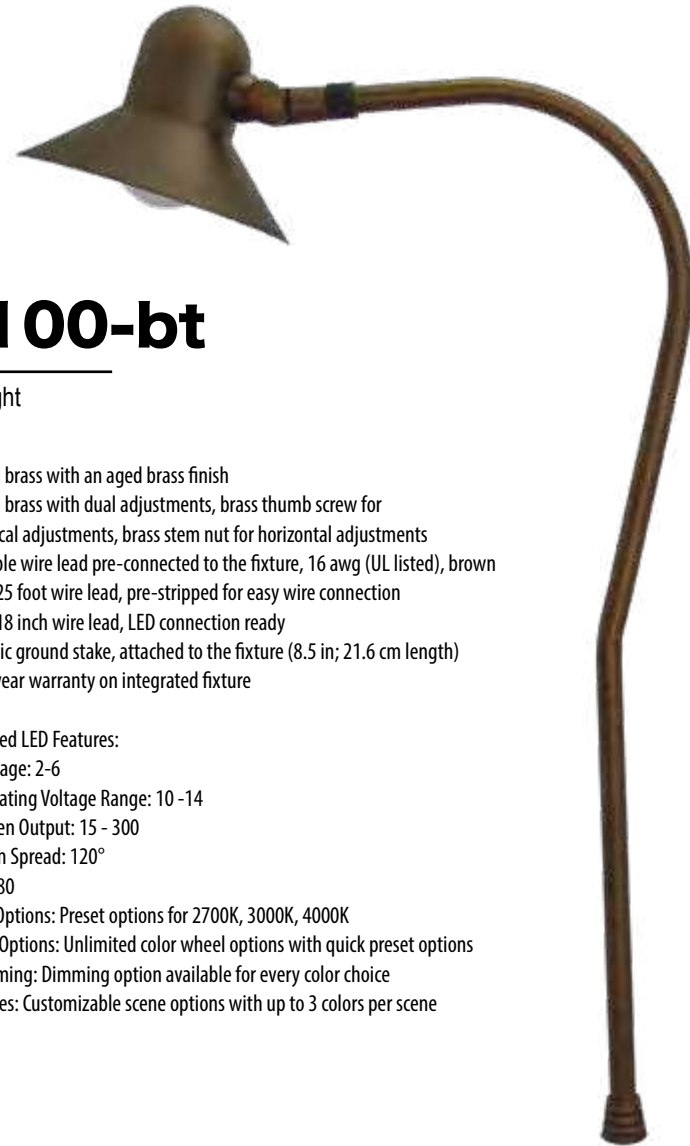

## PL100-bt

bt Path Light

- Solid brass with an aged brass finish
- Solid brass with dual adjustments, brass thumb screw for vertical adjustments, brass stem nut for horizontal adjustments
- Double wire lead pre-connected to the fixture, 16 awg (UL listed), brown
  - 25 foot wire lead, pre-stripped for easy wire connection
  - 18 inch wire lead, LED connection ready
- Plastic ground stake, attached to the fixture (8.5 in; 21.6 cm length)
- Ten year warranty on integrated fixture

### Integrated LED Features:

- Wattage: 2-6
- Operating Voltage Range: 10 -14
- Lumen Output: 15 - 300
- Beam Spread: 120°
- CRI: 80
- CCT Options: Preset options for 2700K, 3000K, 4000K
- RGB Options: Unlimited color wheel options with quick preset options
- Dimming: Dimming option available for every color choice
- Scenes: Customizable scene options with up to 3 colors per scene

## PL300-bt

bt Path Light

- Brass stem with 90°, aged brass finish
- Frosted Lens
- Double wire lead pre-connected to the fixture, 16 awg (UL listed), brown
  - 25 foot wire lead, pre-stripped for easy wire connection
  - 18 inch wire lead, LED connection ready
- Plastic ground stake (8.5 in; 21.6 cm length)





- Ten year warranty on integrated fixture

### Integrated LED Features:

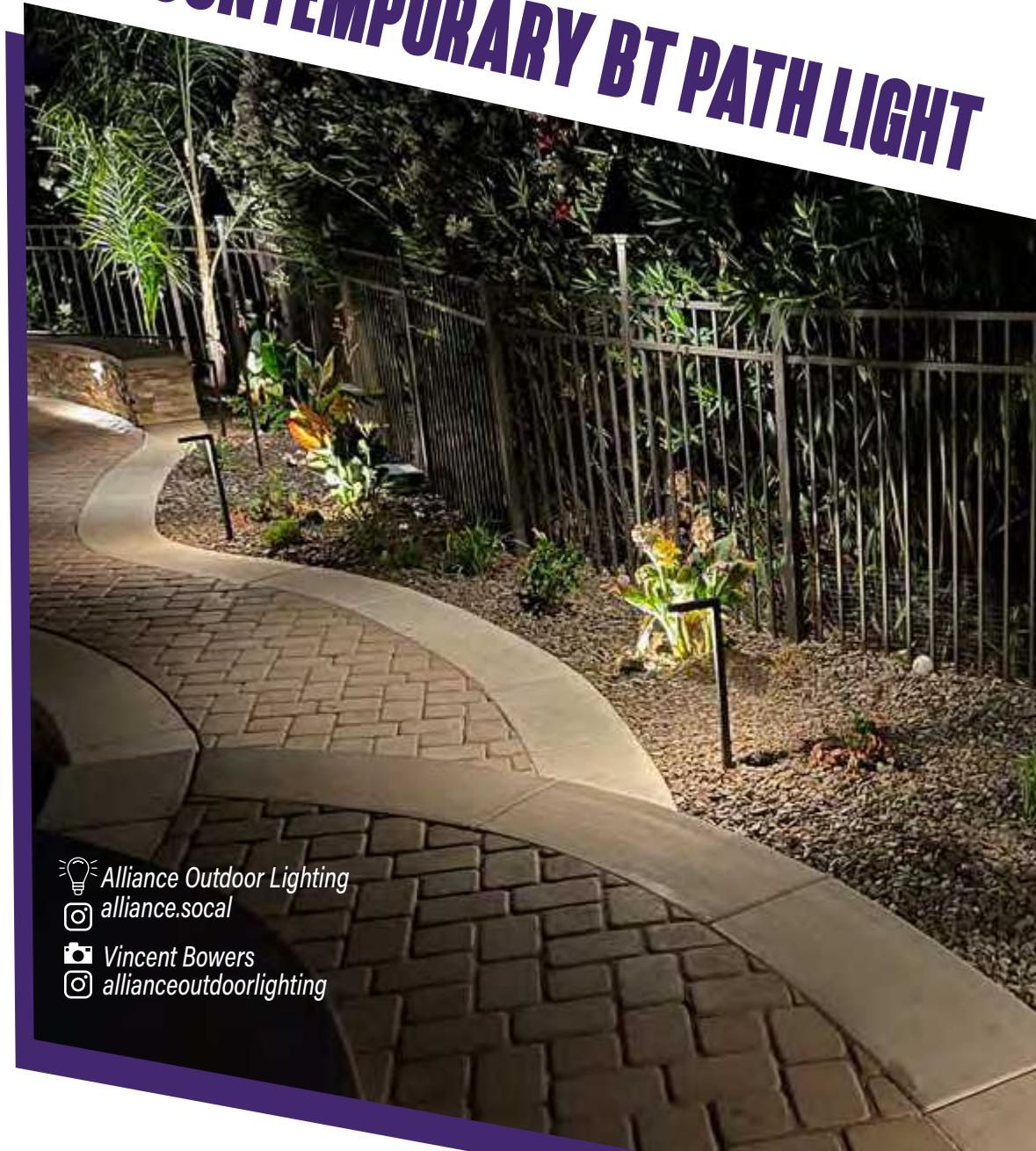
- Wattage: 1-3
- Operating Voltage Range: 10-14
- Lumen Output: 15 - 200
- Beam Spread: 120°
- CRI: 80
- CCT Options: Preset options for 2700K, 3000K, 4000K
- RGB Options: Unlimited color wheel options with quick preset options
- Dimming: Dimming option available for every color choice
- Scenes: Customizable scene options with up to 3 colors per scene

# CONTEMPORARY BT PATH LIGHT



 Alliance Outdoor Lighting  
 alliance.socal  
 Vincent Bowers  
 allianceoutdoorlighting

# CHOOSE A BASE AND TOP

The GL100 and GL300 series both come with 6 tops to choose from. The GL300 is a larger ground light with a polycarbonate base and the smaller GL100 is solid brass with a double wire lead. Both come loaded with all of the great bt features:

### GL100 Series Features:

- Cast brass fixture, aged brass finish
- Casted brass faceplate with 4 screws
- Clear glass lens with gasket
- Double wire lead pre-connected to the fixture, 16 awg (UL listed), brown
  - 25 foot wire lead, pre-stripped for easy wire connection
  - 18 inch wire lead, LED connection ready
- PVC Sleeve
- Ten year warranty

### Integrated LED Features:

- Wattage: 2-8
- Operating Voltage Range: 10 -14
- Lumen Output: 15 - 350
- Beam Spread: 40°
- CRI: 80
- CCT Options: Preset options for 2700K, 3000K, 4000K
- RGB Options: Unlimited color wheel options with quick preset options
- Dimming: Dimming option available for every color choice
- Scenes: Customizable scene options with up to 3 colors per scene



**GL100-bt**

Faceplate with shroud and convex glass lens

**GL150-bt**

Faceplate with convex glass lens

**HL100-bt**



The shroud on the HL100 is easily extendable.

**HL200-bt**



**DL200-bt**



## bt Down Lights

- Cast brass fixture, aged brass finish
- 25 Foot wire lead, 16 awg (UL listed), brown, pre-connected to the fixture, pre-stripped for easy wire connection
- Ten year warranty on integrated fixture

### DL200-bt

- Cast brass knuckle with dial adjustment
- Fully adjustable brass shroud
- Brass mounting bracket

### HL100-bt/HL200-bt

- Adjustable brass shroud (HL100)
- Twinkle-cut brass shroud (HL200)
- Solid brass chain ring with 18" Chain

### Integrated LED Features:

- Wattage: 4-8
- Operating Voltage Range: 10 -14
- Lumen Output: 15 - 350
- Beam Spread: 40°
- CRI: 80
- CCT Options: Preset options for 2700K, 3000K, 4000K
- RGB Options: Unlimited color wheel options with quick preset options
- Dimming: Dimming option available for every color choice
- Scenes: Customizable scene options with up to 3 colors per scene

**GL300-bt**

Faceplate with convex glass lens

**GL350-bt**

Faceplate with shroud and convex glass lens



### GL300 Series Features:

- Solid brass faceplate with five screws
- Clear glass lens
- ABS fixture base with rubber gasket seal
- Ceramic bi-pin socket with adjustable swivel
- 5' wire lead, (UL Listed), black, pre-connected to the fixture, pre-stripped for easy wire connection
- Ten year warranty

### Integrated LED Features:

- Wattage: 2-8
- Operating Voltage Range: 10 -14
- Lumen Output: 15 - 450
- Beam Spread: 40°
- CRI: 80
- CCT Options: Preset options for 2700K, 3000K, 4000K
- RGB Options: Unlimited color wheel options with quick preset options
- Dimming: Dimming option available for every color choice
- Scenes: Customizable scene options with up to 3 colors per scene

### Faceplate Options:

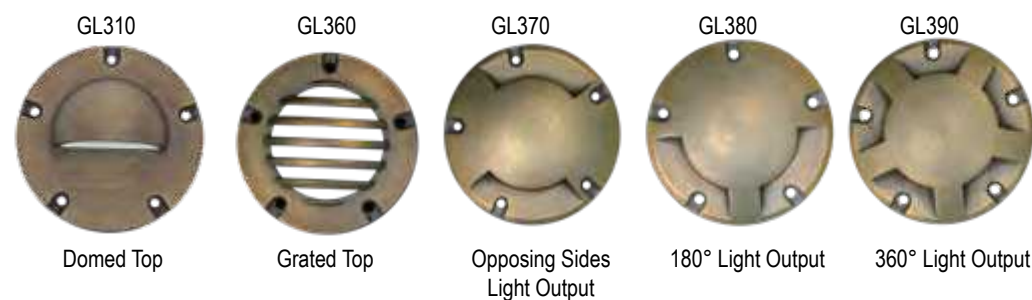

Longshadow Ranch Winery  
 longshadowranchwinery  
 Vincent Bowers  
 allianceoutdoorlighting

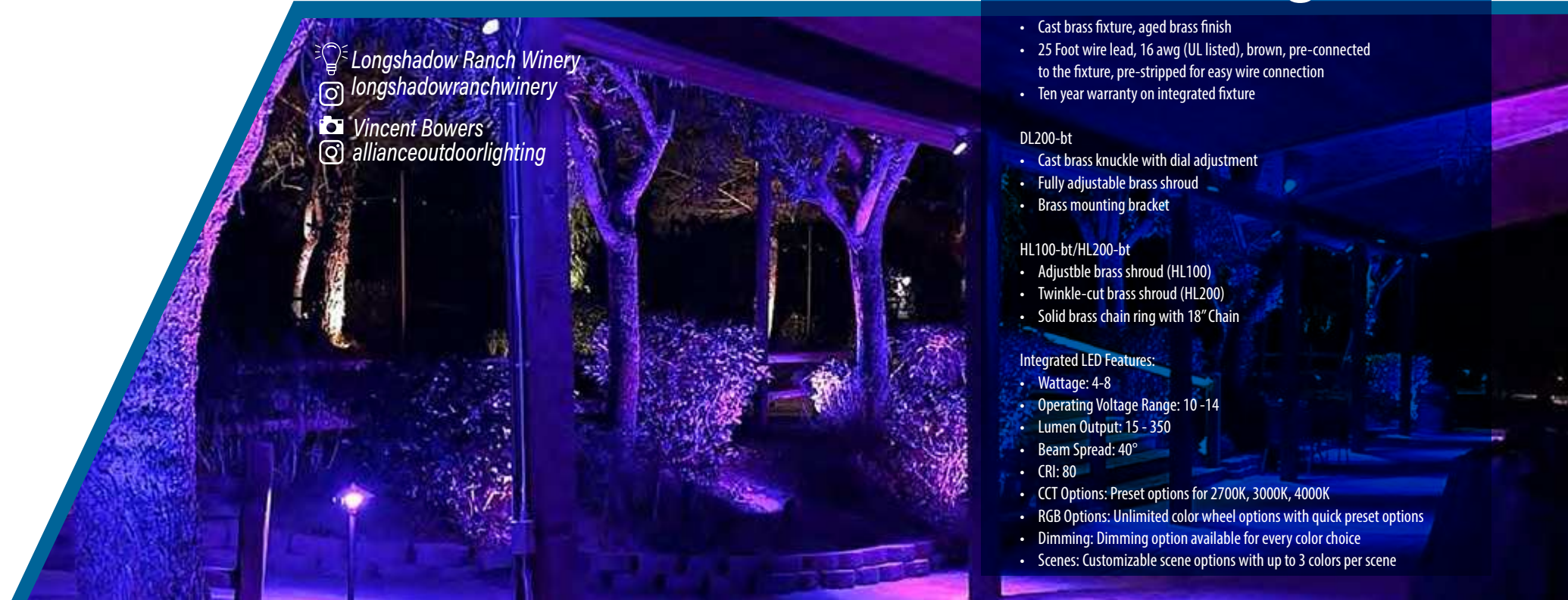

SL25-bt/SL35-bt Features:

- Brass fixture, aged brass finish
- Solid brass louvered face plate with frosted lens
- 25" Wire lead
- Ten Year warranty on integrated fixture

SL25-bt Integrated LED:

- Wattage: 1-4
- Operating Voltage Range: 10 - 14
- Lumen Output: 15 - 200
- Beam Spread: 40°
- CRI: 80
- CCT Options: Preset options for 2700K, 3000K, 4000K
- RGB Options: Unlimited Color Wheel Options with quick preset options
- Dimming: Dimming option available for every color choice
- Scenes: Customizable scene options with up to 3 colors per scene
- \*Louvered face plate greatly reduces glare

SL35-bt Integrated LED:

- Wattage: 2-5
- Operating Voltage Range: 10 - 14
- Lumen Output: 15 - 300
- Beam Spread: 40°
- CRI: 80
- CCT Options: Preset options for 2700K, 3000K, 4000K
- RGB Options: Unlimited Color Wheel Options with quick preset options
- Dimming: Dimming option available for every color choice
- Scenes: Customizable scene options with up to 3 colors per scene
- \*Louvered face plate greatly reduces lumen output

**SL25-bt**

bt Step Light



**SL35-bt**

bt Step Light



SL50-bt/SL60-bt Features:

- Brass fixture, aged brass finish
- Brass Mounting Plate (SL50-bt)
- Brass Surface Mount (SL60-bt)
- Frosted lens
- 25 Foot wire lead, 16 awg (UL listed), brown, pre-connected to the fixture, pre-stripped for easy wire connection
- Lifetime warranty on fixture housing

SL50-bt/SL60-bt Integrated LED:

- Wattage: 1-3
- Operating Voltage Range: 10 - 14
- Lumen Output: 15 - 200
- Beam Spread: 120°
- CRI: 80
- CCT Options: Preset options for 2700K, 3000K, 4000K
- RGB Options: Unlimited color wheel options with quick preset options
- Dimming: Dimming option available for every color choice
- Scenes: Customizable scene options with up to 3 colors per scene



Alliance Outdoor Lighting  
 alliance.socal  
 Vincent Bowers  
 allianceoutdoorlighting

**SL50-bt**

bt Step Light



For mounting underneath a ledge or wall cap.

**SL60-bt**

bt Step Light



For surface mounted applications.

**UL100-bt**

bt Underwater Light



**bt Underwater Light**

- Brass fixture, aged brass finish
- Solid brass fixture base
- Solid brass shroud with water tight, sealed clear lens
- 25 Foot External Antenna
- 25 Foot underwater wire lead, pre-connected to the fixture
- Ten year warranty on integrated fixture

Integrated LED Features:

- Wattage: 4-8
- Operating Voltage Range: 10 - 14
- Lumen Output: 15 - 350
- Beam Spread: 40°
- CRI: 80
- CCT Options: Preset options for 2700K, 3000K, 4000K
- RGB Options: Unlimited color wheel options with quick preset options
- Dimming: Dimming option available for every color choice
- Scenes: Customizable scene options with up to 3 colors per scene



Gio Leonardo, Bella Terra Landscape Design  
 bellaterralandscape  
 Vincent Bowers  
 allianceoutdoorlighting

**LPAR36-LED-bt**

bt Drop-In PAR36 LED

- Wattage: 2-7 watts
- Operating Voltage Range: 12 - 24
- Lumen Output: 280 - 460
- Beam Spread: 45°
- CRI: >80
- CCT Options: Preset options for 2700K, 3000K, 4000K
- RGB Options: Unlimited color wheel options with quick preset options
- Dimming: Dimming option available for every color choice
- Scenes: Customizable scene options with up to 3 colors per scene



**Retrofit bt**



**WL200-bt**



**BL300-bt**



💡 Moonshine Outdoor Lighting  
moonshineoutdoor  
📷 Elliot Fuerniss Photography  
elliottfuerniss

# connect



# & forget

available in:



App Store



Google play

scan for app



**it150**  
150 Watt Intelligent Transformer  
Two Commons, Two 14V Taps  
Suitable for Indoor or Outdoor use  
DOE Compliant

Dimensions:  
L10.875" x W5.125" x H5.25"



**it300**  
300 Watt Intelligent Transformer  
Three Commons, Three 14V Taps  
Suitable for Indoor or Outdoor use  
DOE Compliant

Dimensions:  
L10.875" x W5.125" x H5.25"

**Features:**  
*Bluetooth Enabled  
Astronomical Timer  
Phone App Driven  
Lifetime Warranty  
For LED Only  
DOE Compliant*

# 18" OR 24" STEM

Area Light Hat Features:  
\*Note: Area light stems are sold separately

- Brass area light hat, aged brass finish
- Polycarbonate frosted lens
- Polycarbonate clear lens
- Rubber gaskets
- Adjustable brass collar with thumb screw
- Lifetime warranty

Area Light Stems Sold Separately:

- ALSTEM12 – 12" Stem
- ALSTEM18 – 18" Stem
- ALSTEM24 – 24" Stem
- ALSTEM60 – 60" Stem
- ALSTEMADJ – 18"-29" Stem



**AL100**  
6.75 in (17.1 cm) Wide  
2.5 in (6.4 cm) Tall



**AL250**  
7.75 in (19.7 cm) Wide  
2 in (5 cm) Tall



**AL400**  
7.5 in (19.0 cm) Wide  
4.75 in (12.1 cm) Tall

# 12" OR 18" STEM



**AL150**  
6.25 in (15.9 cm) Wide  
2 in (5 cm) Tall



**AL300**  
6.25 in (15.9 cm) Wide  
2.75 in (7.0 cm) Tall



**AL500**  
5 in (12.7 cm) Wide  
2.5 in (6.4 cm) Tall



**AL550**  
3.5 in (8.9 cm) Wide  
1.5 in (3.8 cm) Tall

## Choose your stem and hat combo

**AL700**  
8.5 in (21.6 cm) Wide  
4.5 in (11.4 cm) Tall

**AL800**  
12 in (30.5 cm) Wide  
3.5 in (8.9 cm) Tall

**AL750**  
9 in (22.9 cm) Wide  
3.75 in (9.5 cm) Tall

**AL850**  
8 in (20.3 cm) Wide  
4.25 in (10.8 cm) Tall

## COMMERCIAL GRADE HATS

Features:  
\*Note: Area light stems are sold separately

- Brass area light hat, aged brass finish
- Polycarbonate frosted lens
- Rubber gaskets
- Adjustable brass collar with thumb screw
- Lifetime warranty

Recommended Light Stems Sold Separately:

- ALSTEM18 – 18" Stem
- ALSTEM24 – 24" Stem
- ALSTEM60 – 60" Stem

Not compatible with ALSTEM18-bt or ALSTEM12-bt





### Adjustable Collar

If you need more light, thread the collar down, exposing the lamp and providing more light. Unthread the collar to reduce light or eliminate glare. Simply tighten the thumb screw to secure collar for desired spread of light.

#### ALSTEM24-LED

(LBIPIN-LED-200lm lamp included)  
24.5"-25.5" (62.2-64.7 cm) Tall

When you need coverage for a wide area, the ALSTEM24 and a larger hat are the perfect combination.

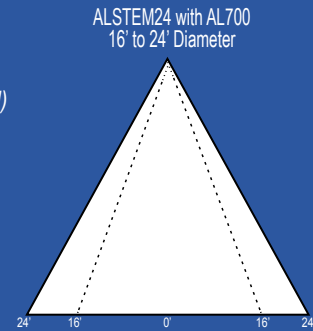

#### ALSTEM18-LED

(LBIPIN-LED-200lm lamp included)  
18.5"-19.5" (47-49.5 cm) Tall

Our most popular choice, the ALSTEM18 is a great pairing for just about any hat.

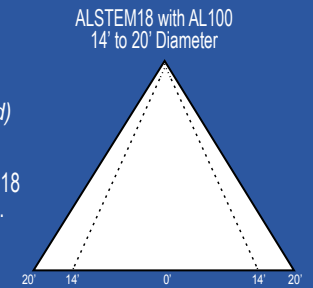

#### ALSTEM12-LED

(LBIPIN-LED-200lm lamp included)  
12.5"-13.5" (31.8-34.2 cm) Tall

The best stem for reducing glare, the ALSTEM12 matches up nicely with a smaller hat.

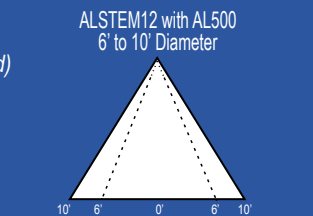

**ALSTEMADJ-LED**  
(LBIPIN-LED-200lm lamp included)  
18"-29" (45.7-73.6 cm) Tall



**ALSTEM60-LED**  
with PERMAPOST included  
(LBIPIN-LED-200lm lamp included)  
60 in (152.4 cm) Tall



**TIKI**  
Specialty Area Light Hat  
8 in (20.3 cm) Wide  
11 in (27.9 cm) Tall



**PERMAPOST**  
Heavy Duty Ground Stake

Area Light Stem Features:  
\*Note: Area light hats are sold separately

- Brass stem, aged brass finish
- Adjustable brass collar with thumb screw (ALSTEM60 excluded)
- Ceramic bi-pin socket
- Double wire lead pre-connected to the fixture, 16 awg (UL listed), brown
  - 25 foot wire lead, pre-stripped for easy wire connection
  - 18 inch wire lead, LED connection ready
- Plastic ground stake (8.5 in; 21.6 cm length) (ALSTEM60 excluded)
- PERMAPOST ABS stake with brass cap on ALSTEM60
- Lifetime warranty on fixture housing
- Available without a lamp

TIKI Features:  
\*Note: Area light stems are sold separately

- Brass area light hat, aged brass finish
- Metal snuffing cap with chain
- Wick with brass holder
- Solid brass collar
- Lifetime warranty

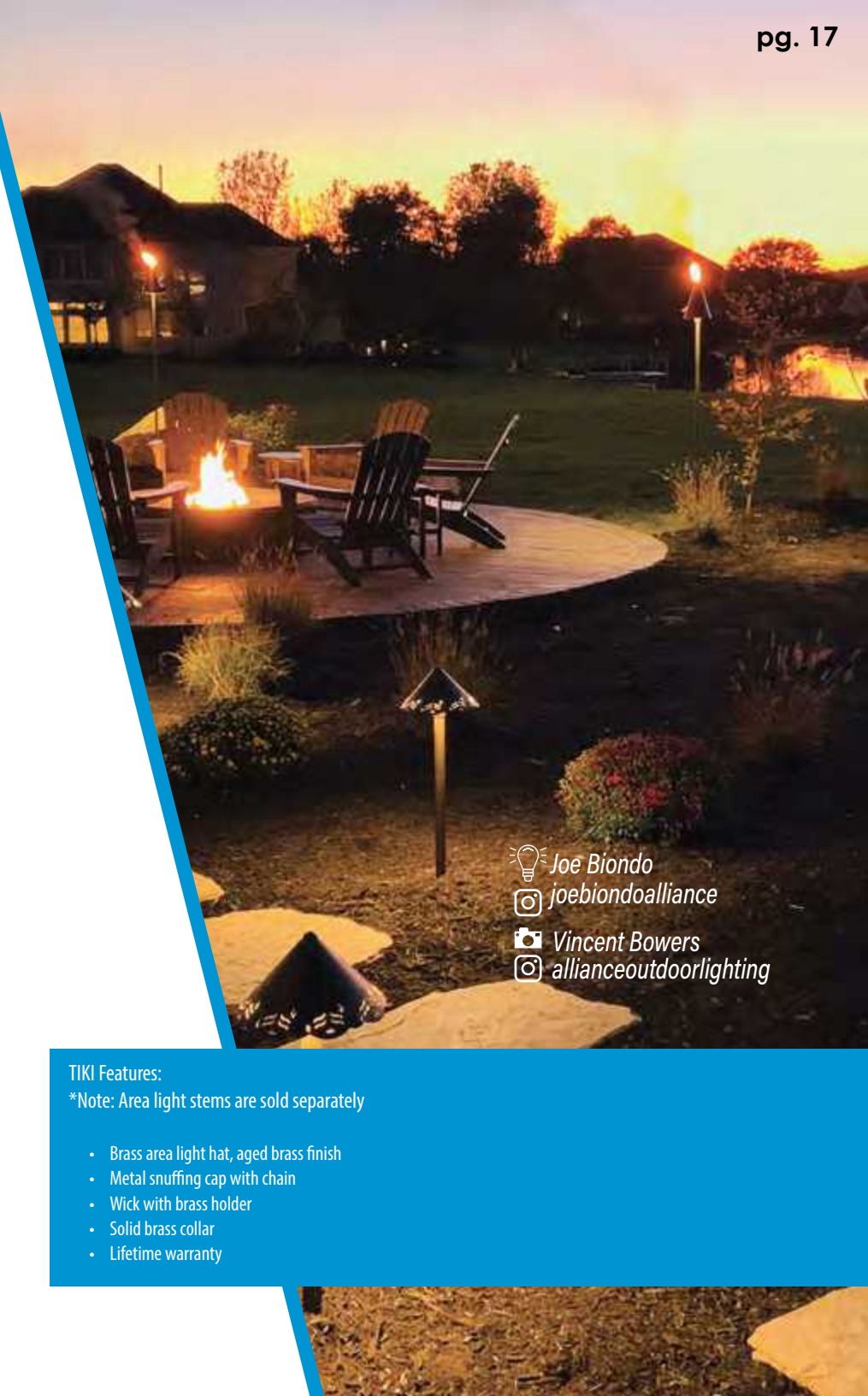

Joe Biondo  
joebiondoalliance  
Vincent Bowers  
allianceoutdoorlighting



Greg Bobich, Watermark Landscape  
watermarklandscape

Vincent Bowers  
allianceoutdoorlighting

## HOW TO LIGHT A PATHWAY

Alternate your fixtures on each side of the path so that the next fixture lights up the other side of the path. This will provide an even light output along the path as well an aesthetically pleasing lighting design. The PL-Series of fixtures include both the hat and the stem. The PL100 has a fully adjustable hat that will rotate up, down and all around. The PL200 and PL250 have a height adjustable stem and solid brass stakes. The GOLF100 is the perfect fixture for putting greens or any path that needs a wider output of light.

### PL100-LED

(LBIPIN-LED-200lm lamp included)  
Fixture Height: 19.1 in. (48.5 cm)  
Fixture Length: 10 in. (25.4 cm)  
Hat Height: 4.2 in. (10.7 cm)  
Hat Diameter: 5.2 in. (13.2 cm)

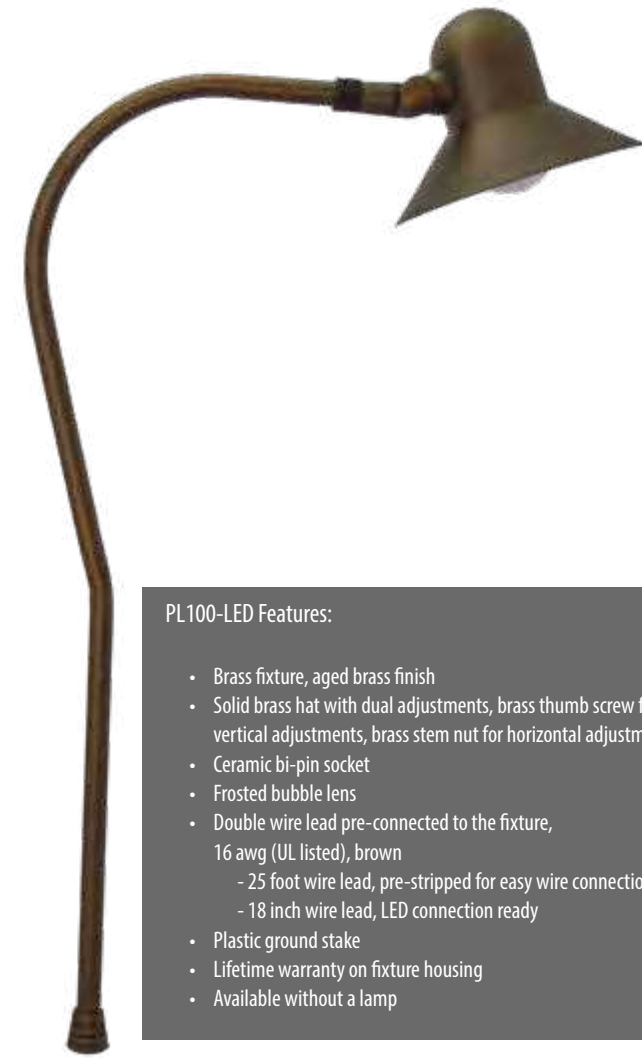

#### PL100-LED Features:

- Brass fixture, aged brass finish
- Solid brass hat with dual adjustments, brass thumb screw for vertical adjustments, brass stem nut for horizontal adjustments
- Ceramic bi-pin socket
- Frosted bubble lens
- Double wire lead pre-connected to the fixture, 16 awg (UL listed), brown
  - 25 foot wire lead, pre-stripped for easy wire connection
  - 18 inch wire lead, LED connection ready
- Plastic ground stake
- Lifetime warranty on fixture housing
- Available without a lamp

### PL200-LED

(LBIPIN-LED-200lm lamp included)  
Fixture Height: 17-27 in. (43.1-68.5 cm)  
Hat Diameter: 7 in (17.8 cm)



### PL250-LED

(LBIPIN-LED-200lm lamp included)  
Fixture Height: 17-27 in. (43.1-68.5 cm)  
Hat Diameter: 4 in (10.1 cm)



#### PL200-LED and PL250-LED Features:

- Solid brass area light hat
- Clear glass lens
- Adjustable brass stem, 17"-27" length, aged brass finish
- Ceramic bi-pin socket
- 25 Foot wire lead, 16 awg (UL listed), brown, pre-connected to the fixture, pre-stripped for easy wire connection
- Solid brass stake (8.5 in; 21.6 cm length)
- Lifetime warranty on fixture housing
- Available without a lamp

### GOLF100-LED

(LBIPIN-LED-200lm lamp included)  
Stem Height: 23.26 in. (59 cm)  
Fixture Length: 5 in. (12.7 cm)  
Fixture Width: 3.75 in. (9.5 cm)  
Base Height: 2.25 in. (5.7 cm)



#### GOLF100 Feature:

- Brass riser with a 45° angle
- Brass fixture, aged brass finish
- Solid brass knuckle with dial adjustment
- Brass face plate with rubber gasket attached to fixture with 4 screws
- Clear lens
- Spring loaded ceramic bi-pin socket with dual contact
- 25 Foot wire lead, 16 awg (UL listed), brown, pre-connected to the fixture, pre-stripped for easy wire connection
- Plastic ground stake (8.5 in; 21.6 cm length)
- Lifetime warranty on fixture housing
- Available without a lamp

# BULLET LIGHTS



Bullet lights can be used to uplight trees, natural structures, columns, bushes, planter areas, walls and more. Use them on a stake in low traffic areas. Anything taller than you should receive at least 310 lumens. Anything shorter than you can use a 250 lumen and lower lamp.

Reno Laatsch, Vision Pool Co.  
visionpoolco

- Bullet Light Features:**
- Cast brass fixture, aged brass finish
  - Cast brass knuckle with dial adjustment
  - Fully adjustable brass shroud
  - Ceramic bi-pin socket with lamp clip (MR11 and MR16)
  - Clear glass lens (BL300 excluded)
  - Double wire lead pre-connected to the fixture, 16 awg (UL listed), brown
    - 25 foot wire lead, pre-stripped for easy wire connection
    - 18 inch wire lead, LED connection ready
  - Plastic ground stake (8.5 in; 21.6 cm length)
  - Lifetime warranty on fixture housing
  - Available without a lamp



**BL50-LED**  
(4 watt, 250lm MR11 LED lamp included)

Fixture Length: 6 in. (15.2 cm)  
Base Height: 1.75 in. (4.4 cm)  
Width: 1.75 in. (4.4 cm)



**BL110-LED6W**  
(6 watt, 410lm MR16 LED lamp included)

**BL110-LED5W**  
(5 watt, 310lm MR16 LED lamp included)

**BL110-LED4W**  
(4 watt, 250lm MR16 LED lamp included)

Fixture Length: 7.5 in. (19 cm)  
Base Height: 1.75 in. (4.4 cm)  
Width: 2.25 in. (5.7 cm)



**BL300-LED10W**  
(10 watt, 400lm PAR36 LED Lamp included)

**BL300-LED8W**  
(8 watt, 300lm PAR36 LED Lamp included)

**BL300-LED4W**  
(4 watt, 250lm PAR36 LED Lamp included)

Fixture Length: 4.25 in. (10.8 cm)  
Base Height: 1.75 in. (4.4 cm)  
Width: 5 in. (12.7 cm)



**BL200-LED6W**  
(6 watt, 410lm MR16 LED lamp included)

**BL200-LED5W**  
(5 watt, 310lm MR16 LED lamp included)

**BL200-LED4W**  
(4 watt, 250lm MR16 LED lamp included)

Fixture Length: 7.25 in. (18.4 cm)  
Base Height: 1.75 in. (4.4 cm)  
Width: 2.5 in. (6.3 cm)







**BL900-LED6W**  
(6 watt, 410lm MR16 LED lamp included)

**BL900-LED5W**  
(5 watt, 310lm MR16 LED lamp included)

**BL900-LED4W**  
(4 watt, 250lm MR16 LED lamp included)

Fixture Length: 7.3 in. (18.5 cm)  
Base Height: 1.75 in. (4.4 cm)  
Width: 2.25 in. (5.7 cm)



 Longshadow Ranch Winery  
 longshadowranchwinery  
 Mark Natale  
 alliance\_norcal

# DOWN LIGHTS

**HL100-LED6W**  
(6 watt MR16 LED lamp included)

**HL100-LED5W**  
(5 watt MR16 LED lamp included)

**HL100-LED4W**  
(4 watt MR16 LED lamp included)

Fixture Height: 6 in. (15.2 cm)  
 Fixture Width: 2.25 in. (5.7 cm)  
 Chain Length: 18 in. (45.7 cm)



The shroud on the HL100 is extendable.



**HL200-LED**  
(LBIPIN-LED-200lm lamp included)

Fixture Height: 7.25 in. (18.4 cm)  
 Fixture Width: 2.25 in. (5.71 cm)  
 Chain Length: 18 in. (45.7 cm)

### Hanging Light Features:

- Brass fixture, aged brass finish
- Cast brass base with ring
- Adjustable brass shroud on HL100
- Brass shroud with twinkle cutouts on HL200
- Ceramic bi-pin socket with lamp clip on HL100
- Ceramic bi-pin socket on HL200
- Threaded aged brass chain, 18" length
- 25 Foot wire lead, 16 awg (UL listed), brown, pre-connected to the fixture, pre-stripped for easy wire connection
- Lifetime warranty on fixture housing
- Available without a lamp

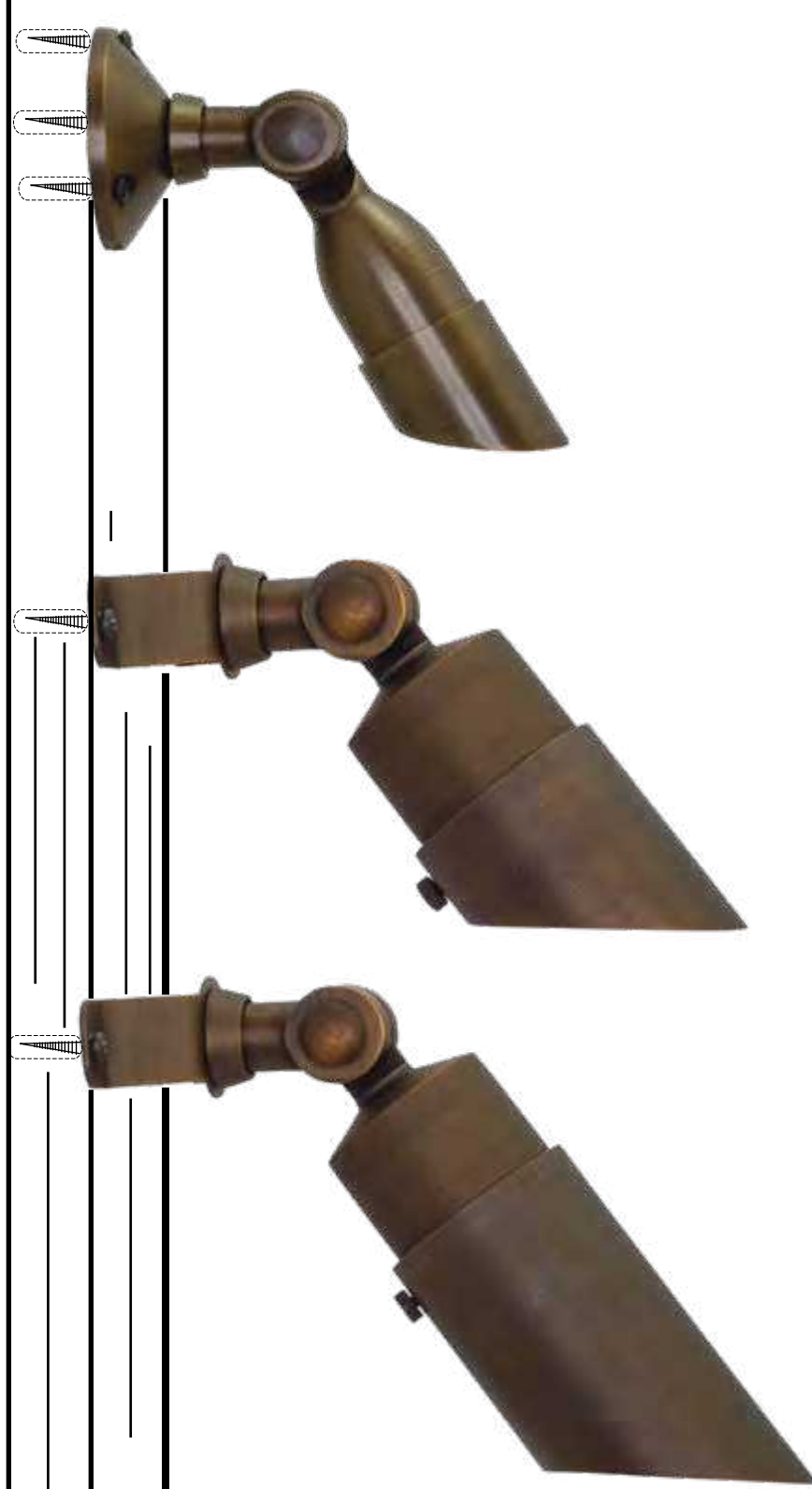

**DL50-LED**  
(4 watt MR11 LED lamp included)  
 Fixture Height: 5.75 in. (14.6 cm)  
 Fixture Width: 1.75 in. (4.4 cm)  
 Base Height: 2.75 in. (7 cm)  
 Mounting Base Width 4.5 in (11.4 cm)

**DL100-LED6W**  
(6 watt MR16 LED Lamp included)

**DL100-LED5W**  
(5 watt MR16 LED Lamp included)

**DL100-LED4W**  
(4 watt MR16 LED Lamp included)

Fixture Height: 6.5 in. (16.5 cm)  
 Fixture Width: 2.5 in. (6.3 cm)  
 Base Height: 3 in. (7.6 cm)  
 Mounting Base Width: 4.5 in. (11.4 cm)

**DL200-LED6W**  
(6 watt MR16 LED Lamp included)

**DL200-LED5W**  
(5 watt MR16 LED Lamp included)

**DL200-LED4W**  
(4 watt MR16 LED Lamp included)

Fixture Height: 8 in. (20.3 cm)  
 Fixture Width: 2.5 in. (6.3 cm)  
 Base Height: 3 in. (7.6 cm)  
 Mounting Base Width: 4.5 in. (11.4 cm)

### Down Light Features:

- Brass fixture, aged brass finish
- Solid brass knuckle with dial adjustment
- Brass shroud with rubber gasket
- Ceramic bi-pin socket with lamp clip
- 25 Foot wire lead, 16 awg (UL listed), brown, pre-connected to the fixture, pre-stripped for easy wire connection
- Solid brass mounting bracket, aged brass finish (DL100 and DL200)
- Brass mounting nut for precise adjustment (DL100 and DL200)
- Aged brass round mounting base (DL50)
- Mounting screws
- Lifetime warranty on fixture housing
- Available without a lamp

 Mark Natale  
 alliance\_norcal  
 Mark Natale  
 alliance\_norcal

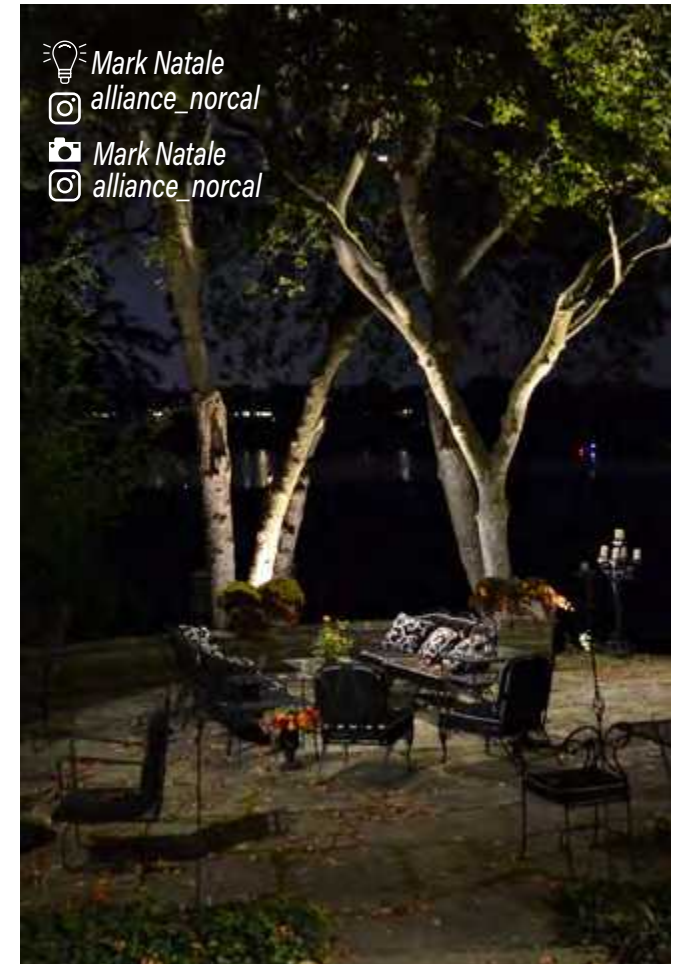

# INDEX



bt PRODUCTS.....2-11  
 INTELLIGENT DEVICES ..... 12-13  
 AREA LIGHTS ..... 14-17  
 PATH LIGHTS..... 18-19  
 BULLET LIGHTS..... 20-21  
 DOWN LIGHTS..... 22-23  
 TABLE OF CONTENTS..... 24-25  
 FLOOD LIGHTS..... 26  
 IN -GROUND LIGHTS..... 28-31  
 STEP LIGHTS..... 32-35  
 POST LIGHT..... 36  
 BOLLARD LIGHT..... 36  
 WALL SCONCE LIGHTS..... 38  
 UNDERWATER LIGHT..... 39  
 DEMOKITS..... 40  
 TRANSFORMERS..... 41  
 ACCESSORIES..... 43  
 LED LAMPS..... 44  
 WARRANTY..... 47  
 REFERENCE PAGE..... 47

# FLOOD LIGHTS



**FL50-LED**  
(LBIPIN-LED-200lm lamp included)  
Fixture Height: 2 in. (5.0 cm)  
Fixture Width: 4 in. (10.1 cm)  
Fixture Depth: 2.25 in. (5.7 cm)  
Base Height: 1.5 in. (3.8 cm)



**FL50-FFP**  
Frosted face plate sold separately

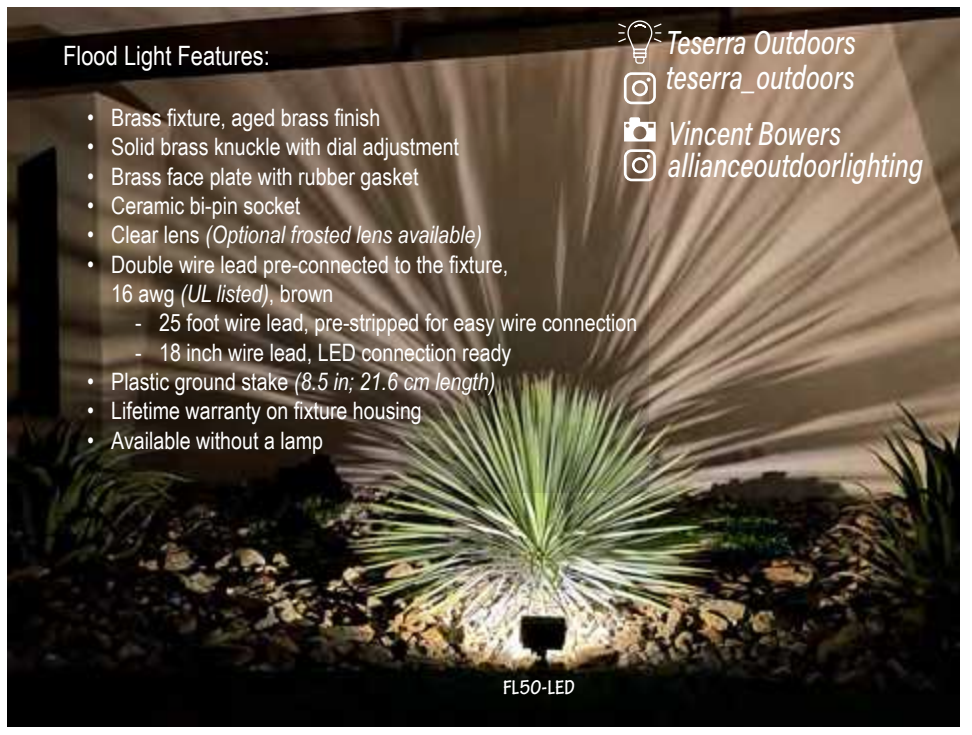

- Flood Light Features:
- Brass fixture, aged brass finish
  - Solid brass knuckle with dial adjustment
  - Brass face plate with rubber gasket
  - Ceramic bi-pin socket
  - Clear lens (Optional frosted lens available)
  - Double wire lead pre-connected to the fixture, 16 awg (UL listed), brown
    - 25 foot wire lead, pre-stripped for easy wire connection
    - 18 inch wire lead, LED connection ready
  - Plastic ground stake (8.5 in; 21.6 cm length)
  - Lifetime warranty on fixture housing
  - Available without a lamp
- Teserra Outdoors  
teserra\_outdoors  
Vincent Bowers  
allianceoutdoorlighting

FL50-LED

**FL200-LED6W**  
(6 watt MR16 LED lamp included)

**FL200-LED5W**  
(5 watt MR16 LED lamp included)

**FL200-LED4W**  
(4 watt MR16 LED lamp included)

Fixture Height: 4.25 in. (10.8 cm)  
Fixture Width: 5.25 in. (13.3 cm)  
Fixture Depth: 6 in. (15.2 cm)  
Base Height: 3 in. (7.6 cm)



**FL100-LED**  
(LBIPIN-LED-200lm lamp included)  
Fixture Height: 5 in. (12.7 cm)  
Fixture Width: 3.75 in. (9.5 cm)  
Base Height: 2.25 in. (5.7 cm)



**FL100-FFP**  
Frosted face plate sold separately



Moonshine Outdoor Lighting  
moonshineoutdoor  
Elliot Fuerniss Photography  
elliottfuerniss

# IN-GROUND LIGHTS

## GL-BASE

3.5 in. (8.9 cm) Width at Base Top  
2.38 in. (6.0 cm) Width at Base Bottom  
3.5 in (8.9 cm) Tall

### GL100-LED6W

(6 watt MR16 LED lamp included)



### GL100-LED5W

(5 watt MR16 LED lamp included)

### GL100-LED4W

(4 watt MR16 LED lamp included)

### GL150-LED6W

(6 watt MR16 LED lamp included)

### GL150-LED5W

(5 watt MR16 LED lamp included)

### GL150-LED4W

(4 watt MR16 LED lamp included)



### GL160-LED6W

(6 watt MR16 LED lamp included)



### GL160-LED5W

(5 watt MR16 LED lamp included)

### GL160-LED4W

(4 watt MR16 LED lamp included)

### GL170-LED6W

(6 watt MR16 LED lamp included)



### GL170-LED5W

(5 watt MR16 LED lamp included)

### GL170-LED4W

(4 watt MR16 LED lamp included)

### GL180-LED6W

(6 watt MR16 LED lamp included)



### GL180-LED5W

(5 watt MR16 LED lamp included)

### GL180-LED4W

(4 watt MR16 LED lamp included)

### GL190-LED6W

(6 watt MR16 LED lamp included)



### GL190-LED5W

(5 watt MR16 LED lamp included)

### GL190-LED4W

(4 watt MR16 LED lamp included)

## GL300-BASE

4.87 in. (12.3 cm) Width at Base Top  
3.5 in. (8.9 cm) Width at Base Bottom  
4.75 in. (12 cm) Base Height  
0.5 in. (1.2 cm) Lip Height



### GL300-LED6W

(6 watt MR16 LED lamp included)

### GL300-LED5W

(5 watt MR16 LED lamp included)

### GL300-LED4W

(4 watt MR16 LED lamp included)



### GL310-LED6W

(6 watt MR16 LED lamp included)

### GL310-LED5W

(5 watt MR16 LED lamp included)

### GL310-LED4W

(4 watt MR16 LED lamp included)



### GL350-LED6W

(6 watt MR16 LED lamp included)

### GL350-LED5W

(5 watt MR16 LED lamp included)

### GL350-LED4W

(4 watt MR16 LED lamp included)



### GL360-LED6W

(6 watt MR16 LED lamp included)

### GL360-LED5W

(5 watt MR16 LED lamp included)

### GL360-LED4W

(4 watt MR16 LED lamp included)



### GL370-LED6W

(6 watt MR16 LED lamp included)

### GL370-LED5W

(5 watt MR16 LED lamp included)

### GL370-LED4W

(4 watt MR16 LED lamp included)



### GL360-LED6W

(6 watt MR16 LED lamp included)

### GL360-LED5W

(5 watt MR16 LED lamp included)

### GL360-LED4W

(4 watt MR16 LED lamp included)



### GL370-LED6W

(6 watt MR16 LED lamp included)

### GL370-LED5W

(5 watt MR16 LED lamp included)

### GL370-LED4W

(4 watt MR16 LED lamp included)

Faceplate Options:

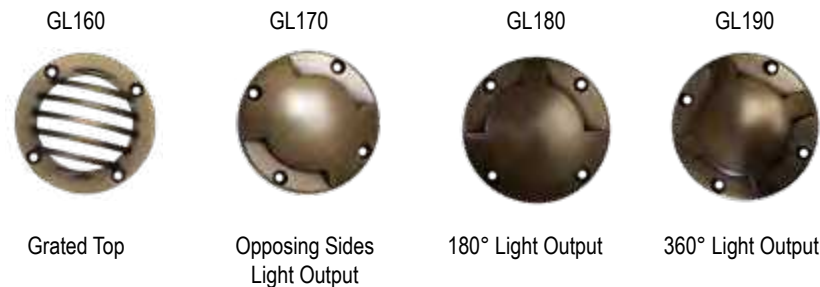

#### GL100 Series Features:

- Brass fixture, aged brass finish
- Clear convex lens
- Solid brass fixture base
- Solid brass faceplate with four screws
- Ceramic bi-pin socket
- Double wire lead pre-connected to the fixture, 16 awg (UL listed), brown
  - 25 foot wire lead, pre-stripped for easy wire connection
  - 18 inch wire lead, LED connection ready
- Lifetime warranty on fixture housing
- Available without a lamp

#### GL300 Series Features:

- Solid brass faceplate with five screws
- Clear glass lens
- ABS fixture base with rubber gasket seal
- Ceramic bi-pin socket with adjustable swivel
- 5' wire lead, (UL Listed), black, pre-connected to the fixture, pre-stripped for easy wire connection
- Lifetime warranty on fixture housing
- Available without a lamp

Faceplate Options:

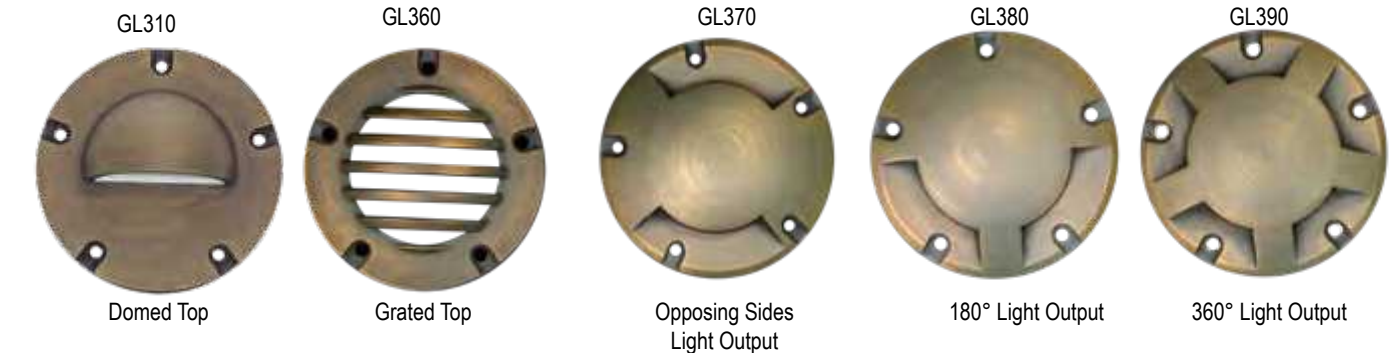



# WELL LIGHTS

### WL300-LED6W

(6 watt MR16 LED lamp included)

### WL300-LED5W

(5 watt MR16 LED lamp included)

### WL300-LED4W

(4 watt MR16 LED lamp included)

Fixture Height: 7.5 in. (19.0 cm)  
Can Diameter: 5.75 in. (14.6 cm)  
Grate Diameter: 6.5 in. (16.5 cm)



The height of the lamp housing in the WL300 is easily adjustable.



### WL100-LED10W

(10 watt PAR36 LED lamp included)

### WL100-LED8W

(8 watt PAR36 LED lamp included)

### WL100-LED4W

(4 watt PAR36 LED lamp included)

Fixture Height: 8.75 in. (22.2 cm)  
Can Diameter: 5.5 in. (13.9 cm)  
Grate Diameter: 6 in. (15.2 cm)



### WL200-LED10W

(10 watt PAR36 LED lamp included)

### WL200-LED8W

(8 watt PAR36 LED lamp included)

### WL200-LED4W

(4 watt PAR36 LED lamp included)

Fixture Height: 8.75 in. (22.2 cm)  
Can Diameter: 5.5 in. (13.9 cm)  
Grate Diameter: 5.5 in. (13.9 cm)



### CGWL01-LED10W

(10 watt PAR36 LED lamp included)

### CGWL01-LED8W

(8 watt PAR36 LED lamp included)

### CGWL01-LED4W

(4 watt PAR36 LED lamp included)

Fixture Height: 8.25 in. (20.9 cm)  
Can Diameter: 5.5 in. (13.9 cm)  
Grate Diameter: 6.75 in. (17.1 cm)







**TAPE-LED-5FT**  
Integrated LED Step Light  
Can be cut down to length  
LED strip, 5 Feet  
• Watts: 5w  
• Light Output: 350 lm (Lumens)

Per 1 Foot:  
• Watts: 1w  
• Light Output: 70 lm (Lumens)

Can be Cut Down to Size



**TAPE-LED-15FT**  
Integrated LED Step Light  
Can be cut down to length  
LED strip, 15 Feet  
• Watts: 15w  
• Light Output: 1050 lm (Lumens)

Per 1 Foot:  
• Watts: 1w  
• Light Output: 70 lm (Lumens)

**TAPE-LED-15FT-LL**  
Lower Lumen Output  
• Watts: 8w  
• Light Output: 675 lm (Lumens)

Per 1 Foot:  
• Watts: 0.5w  
• Light Output: 45 lm (Lumens)

**TAPE-LED-30FT**  
Integrated LED Step Light  
Can be cut down to length  
LED strip, 30 Feet  
• Watts: 30w  
• Light Output: 2,100 lm (Lumens)

Per 1 Foot:  
• Watts: 1w  
• Light Output: 70 lm (Lumens)

# TAPE LIGHTS

## TAPE-LED Features:

- Mounting clips included
- 10' wire lead, 16 awg (UL Listed), brown, pre-connected to the fixture, pre-stripped for easy wire connection
- 10 Year warranty on LED components and fixture housing

## LED strip

- Beam Angle: 120°
- Beam Spread: Flood
- Color: Warm White
- Color Temperature: 2700K
- Operating Voltage: 10.8Vac - 15Vac
- CRI: Ra > 80
- Rated Hours: 30,000
- Ambient Operating Temperature: -40°C ~ +85°C



**SL65-LED**  
Integrated LED Step Light  
4 in (10.1 cm) Wide  
3.5 in (8.9 cm) Deep  
LED strip, 4 chips  
• Watts: 2w  
• Light Output: 110 lm (Lumens)



**SL75-LED**  
Integrated LED Step Light  
6.8 in (17.2 cm) Wide  
3.5 in (8.9 cm) Deep  
LED strip, 8 chips  
• Watts: 3w  
• Light Output: 300 lm (Lumens)



**SL85-LED**  
Integrated LED Step Light  
12 in (30.4 cm) Wide  
3.5 in (8.9 cm) Deep  
LED strip, 12 chips  
• Watts: 4w  
• Light Output: 380 lm (Lumens)

# LEDGE LIGHTS

## CHOOSE THE PERFECT SIZE

The 7" SL75-LED is our most popular and works for countless applications.

The 4" SL65-LED will work great on shorter walls and corners.

The 12" SL85-LED is ideal for taller walls and will provide a wider coverage area.

## SL-LED Series Features:

- Brass fixture, aged brass finish
- Mounting bracket, stainless steel, aged brass finish
- Optional frosted lens included
- Optional glare shield included
- 10' wire lead, 16 awg (UL Listed), brown, pre-connected to the fixture, pre-stripped for easy wire connection
- 10 Year warranty on LED components and fixture housing

## VERSATILITY



Mounting bracket is removable for surface mounted applications.  
Optional frosted lens is included with the fixture.



Glare shield included with every SL65-LED, SL75-LED and SL85-LED



SL65-LED with glare shield installed.



- SL25-LED/SL35-LED Features:**
- Brass fixture, aged brass finish
  - Solid brass louvered face plate with frosted lens
  - 25" Wire lead
  - 10 Year warranty on LED components and fixture housing
- SL25-LED Integrated LED:**
- Watts: 7w
  - Lumens: 570lm\*
  - Color: Warm White
  - Color Temperature: 2700K
  - Operating Voltage: 8Vac-15Vac
  - CRI: Ra>80
  - Rated Hours: 30,000 Hours
  - Ambient Operating Temperature: -40°C ~ +85°C
- SL35-LED Integrated LED:**
- Watts: 13w
  - Lumens: 1,000lm\*
  - Color: Warm White
  - Color Temperature: 2700K
  - Operating Voltage: 8Vac-15Vac
  - CRI: Ra>80
  - Rated Hours: 30,000 Hours
  - Ambient Operating Temperature: -40°C ~ +85°C

\*Louvered face plate greatly reduces lumen output

# STEP LIGHTS

## SL50 Features:

- Brass fixture, aged brass finish
- Ceramic bi-pin socket
- Frosted lens
- 25 Foot wire lead, 16 awg (UL listed), brown, pre-connected to the fixture, pre-stripped for easy wire connection
- Lifetime warranty on fixture housing

## SL50-LED

(LBIPIN-LED-200lm lamp included)

Fixture Depth: 3.5 in. (8.9 cm)  
 Fixture Width: 5 in. (12.7 cm)  
 Lamp Housing Height: 1.5 in. (3.8 cm)  
 Lamp Housing Depth: 1.25 in. (3.1 cm)

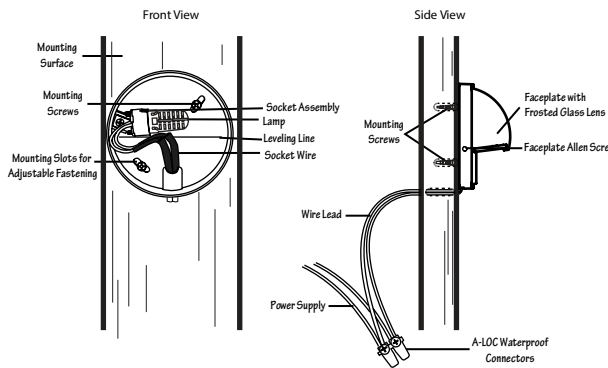

## SL100-LED

(LBIPIN-LED-200lm lamp included)

Fixture Depth: 1.75 in. (4.4 cm)  
 Fixture Diameter: 3.4 in. (8.6 cm)

Fits a Standard 4" Post



## SL150-LED

(LBIPIN-LED-200lm lamp included)

Fixture Depth: 2 in. (5.0 cm)  
 Fixture Diameter: 3.875 in. (9.8 cm)



## SL25-LED

Integrated Surface Mount Step Light

6 in (15.2 cm) Wide  
 2.875 in (7.3 cm) Tall



Mounts directly onto desired surface

(Back View)



(Side View)



## SL35-LED

Integrated Surface Mount Step Light

9.5 in (24.1 cm) Wide  
 2.875 in (7.3 cm) Tall



## SL200 and SL300 Features:

- Brass fixture, aged brass finish
- Solid brass face plate with securing screws
- Ceramic bi-pin socket
- Mud installation box included
- 25 Foot wire lead, 16 awg (UL listed), brown, pre-connected to the fixture, pre-stripped for easy wire connection
- Optional metal set box included
- Lifetime warranty on fixture housing
- Available without a lamp

## SL200-LED

(LBIPIN-LED-200lm lamp included)

(Back View)



(Side View)



## SL300-LED

(Two LBIPIN-LED-200lm lamps included)



- Post Light Features:**
- Brass post light, aged brass finish
  - Frosted lens panels
  - Ceramic bi-pin socket
  - Mounting hardware
  - 25 foot wire lead, 16 awg(UL Listed), brown, pre-connected to the fixture, pre-stripped for easy wire connection
  - Lifetime warranty on fixture housing
  - Available without a lamp

**POST100-LED6W**  
(6 watt MR16 LED lamps included)

**POST100-LED5W**  
(5 watt MR16 LED lamps included)

**POST100-LED4W**  
(4 watt MR16 LED lamps included)

Body Width: 7.75 in. (19.7 cm)  
Body Depth: 7.75 in. (19.7 cm)  
Total Height: 12 in. (30.5 cm)  
Hat Width: 11 in. (27.9 cm)



**BOLLARD100-LED**

(LBIPIN-LED-350lm lamp included)

Base Width: 5 in. (12.7 cm)

Total Height: 29.5 in. (74.9 cm)

Top Height: 7.5 in. (19.0 cm)

Top Width: 6 in. (15.2 cm)

- Bollard Features:**
- Solid brass three-tiered cover, aged brass finish
  - Aluminum post, aged brass finish
  - Clear and frosted polycarbonate lens with gaskets
  - Ceramic bi-pin socket
  - Aluminum mounting base with hardware
  - 36 inch wire lead, 16 awg(UL Listed), brown, pre-connected to the fixture, pre-stripped for easy wire connection
  - Plastic ground stake (8.5 in; 21.6 cm length) (optional)
  - Lifetime warranty on fixture housing
  - Available without a lamp



# WALL SCONCE LIGHTS



**WS100-LED**  
(Two LBIPIN-LED-200lm lamps included)  
Fixture Height: 6 in. (15.2 cm)  
Fixture Width: 3 in. (7.6 cm)  
Fixture Depth: 2 in. (5.0 cm)



**WS200-LED**  
(Two LBIPIN-LED-200lm lamps included)  
Fixture Height: 9 in. (22.8 cm)  
Fixture Width: 6 in. (15.2 cm)  
Fixture Depth: 3.5 in. (8.9 cm)



**WS300-LED6W**  
(Two 6 watt MR16 LED lamps included)  
**WS300-LED5W**  
(Two 5 watt MR16 LED lamps included)  
**WS300-LED4W**  
(Two 4 watt MR16 LED lamps included)  
Fixture Height: 8 in. (20.3 cm)  
Fixture Width: 2.25 in. (5.7 cm)  
Fixture Depth: 3.5 in. (8.9 cm)



**UL100-LED6W**  
(6 watt MR16 LED lamp included)  
**UL100-LED5W**  
(5 watt MR16 LED lamp included)  
**UL100-LED4W**  
(4 watt MR16 LED lamp included)  
Fixture Height: 5 in. (12.7 cm)  
Fixture Width: 4.25 in. (10.8 cm)  
Fixture Depth: 4.25 in. (10.8 cm)



## Wall Sconce Features:

- Brass fixture, aged brass finish
- Frosted top lens (WS100 and WS200)
- Clear glass top and bottom lenses (WS300)
- Dual Ceramic bi-pin socket
- 25 Foot wire lead, 16 awg (UL listed), brown, pre-connected to the fixture, pre-stripped for easy wire connection
- Lifetime warranty on fixture housing
- Available without a lamp

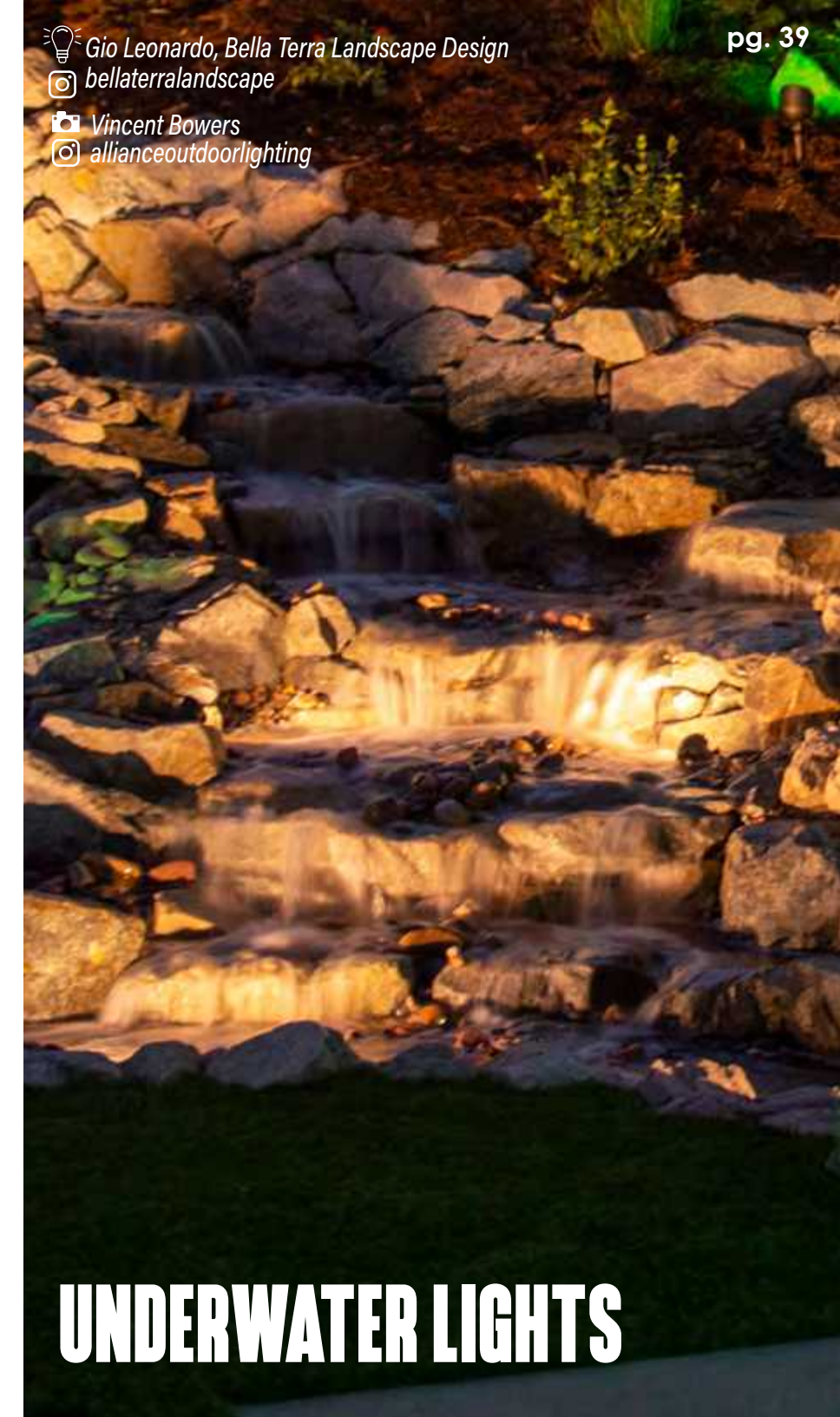

# UNDERWATER LIGHTS

## UL100 Features:

- Brass fixture, aged brass finish
- Solid brass fixture base
- Solid brass shroud with water tight, sealed clear lens
- Ceramic bi-pin socket
- 25 Foot underwater wire lead, pre-connected to the fixture (also available with 50 Foot wire lead)
- UL1838 Certified underwater landscape luminaire
- Lifetime warranty on fixture housing
- Available without a lamp

# DEMO KITS

Quick connects on every wire lead,  
for an easy and fast connection



DEMOKIT8-bt Includes:

- (6) BL200-bt
- (2) ALSTEM12-bt
- (2) AL100 Hats
- (1) bt-RE
- (1) TF150 Transformer
- (2) Wire Splitters
- (12) Extra Connectors
- Storage Case

DEMOKIT8 Includes:

- (6) BL200-LED4W
- (2) ALSTEM12-LED
- (2) AL100 Area Light Hats
- (1) TF150 Transformer
- (2) Wire Splitters
- (12) Extra Connectors
- Storage Case

Demo Kit Features:

- Our industry first double wire leads: fixtures with two 16 awg (UL Listed) brown wire leads pre-connected to the fixture, one 18" and one 25' in length.
- Quick connecting adapters at each wire end making connections fast and easy (not intended for in ground burial)
- A TF150 transformer with an 18" wire lead pre-connected with quick connect adapter
- A compact storage case making the kit easy to store and transport
- Extra quick connectors



**DEMOKIT8-bt**  
(bt Demonstration Kit)

**DEMOKIT8**  
(LED Demonstration Kit)

## GREAT SALES TOOL

A demo kit is a great way to expand your lighting business. Setup the kit for the customer to show how great lighting enhances the way they experience their property at night. Expand your demokit to show different applications of lighting.



(XF150 pictured)

## XF TRANSFORMER ACCESSORIES

**PC**  
Photocell



**TIMER**  
Mechanical Timer



**XF150**

150 watt Transformer

COM1 COM2 12 13 14 15

Dimensions:

L14.37" x W4.72" x H5.12"

**XF300**

300 watt Transformer

COM1 COM2 12 13 14 15

Dimensions:

L15.98" x W7.28" x H5.12"

**XF600**

600 watt Transformer

COM1 12 13 14 15 16 17 18 COM2

Dimensions:

L15.98" x W7.28" x H5.12"



**TF200**

200 Watt Stainless Steel Transformer Featuring:

- One 12 Volt tap only
- Built in photocell/timer
- DOE Compliant

**TF300**

300 Watt Stainless Steel Transformer Featuring:

- Multiple Taps (12v-15v)
- Built in photocell/timer
- DOE Compliant

## CONNECTION ACCESSORIES

**A-LOC-50**

Waterproof Wire Connectors  
(Container of 50 pieces)





**RMB**  
Aged Brass Round Mounting Base



**GUTTERMOUNT**  
Aged Brass Gutter Mount



**T-ADAPTER**  
"T" Extension Accessory



**L-ADAPTER**  
"L" Extension Accessory



**RISERADJ-BRASS**  
Adjustable Brass Riser



**RISER18**  
18" Aged Brass Riser



**RISER12**  
12" Aged Brass Riser



**RISER6**  
6" Aged Brass Riser



**PERMAPOST**  
Heavy Duty Ground Stake



# ACCESSORIES

**LBIPIN-LED-200lm**

2.5 watt bipin, 200 lumens  
IP67 certified



**LBIPIN-LED-250lm**

3 watt bipin, 250 lumens  
IP67 certified

**LBIPIN-LED-350lm**

3.5 watt bipin, 350 lumens  
IP67 certified

**L3156-LED-200lm**

2.5 watt 3156 wedge base, 200 lumens  
IP67 certified



**L3156-LED-250lm**

3 watt 3156 wedge base, 250 lumens  
IP67 certified

**LBA15S-LED-200lm**

2.5 watt single bayonet, 200 lumens  
IP67 certified



**LBA15D-LED-200lm**

2.5 watt double bayonet, 200 lumens  
IP67 certified



**L921T5-LED-200lm**

2.5 watt T5 wedge base, 200 lumens  
IP67 certified



IP67: Lamps are dust tight and can be submerged in up to one meter of water

# DROP-IN LED LAMPS



**LPAR36-LED-4W-F**

4 watt PAR36, 250 lumens, 20 degree

**LPAR36-LED-4W-WF**

4 watt PAR36, 250 lumens, 40 degree  
*(20 watt PAR36 equivalent)*



**LPAR36-LED-8W-F**

8 watt PAR36, 300 lumens, 20 degree

**LPAR36-LED-8W-WF**

8 watt PAR36, 300 lumens, 40 degree  
*(35 watt PAR36 equivalent)*



**LPAR36-LED-10W-F**

10 watt PAR36, 400 lumens, 30 degree

**LPAR36-LED-10W-WF**

10 watt PAR36, 400 lumens, 45 degree  
*(50 watt PAR36 equivalent)*



IP66: Lamps are dust tight and can withstand powerful water jets from any direction.



**LMR11-LED-4W-F**

4 watt MR11, 175 lumens

Flood, 45 degree

*(20 watt MR11 equivalent)*



**LMR16-LED-4W-F**

4 watt MR16, 250 lumens

Flood, 45 degree

*(20 watt MR16 equivalent)*

**LMR16-LED-4W-2700K**

2700K Color Temperature

**LMR16-LED-4W-WF**

Wide Flood, 60 degree



**LMR16-LED-4W-NS**

Narrow Spot, 15 degree



**LMR16-LED-250lm**

Enclosed Housing

Recommended for Down Light Series



**LMR16-LED-5W-F**

5 watt MR16, 310 lumens

Flood, 45 degree

*(35 watt MR16 equivalent)*

**LMR16-LED-5W-2700K**

2700K Color Temperature

**LMR16-LED-5W-WF**

Wide Flood, 60 degree



**LMR16-LED-5W-NS**

Narrow Spot, 15 degree



**LMR16-LED-310lm**

Enclosed Housing

Recommended for Down Light Series



**LMR16-LED-6W-F**

6 watt MR16, 410 lumens

Flood, 45 degree

*(50 watt MR16 equivalent)*

**LMR16-LED-6W-2700K**

2700K Color Temperature



💡 Moonshine Outdoor Lighting  
📷 @moonshineoutdoor  
📷 Elliot Fuerniss Photography  
📷 @elliottfuerniss

# ALLIANCE

OUTDOOR LIGHTING

## Double Wire Lead

- 25' and 18" Wire Leads
- Save Time and Money

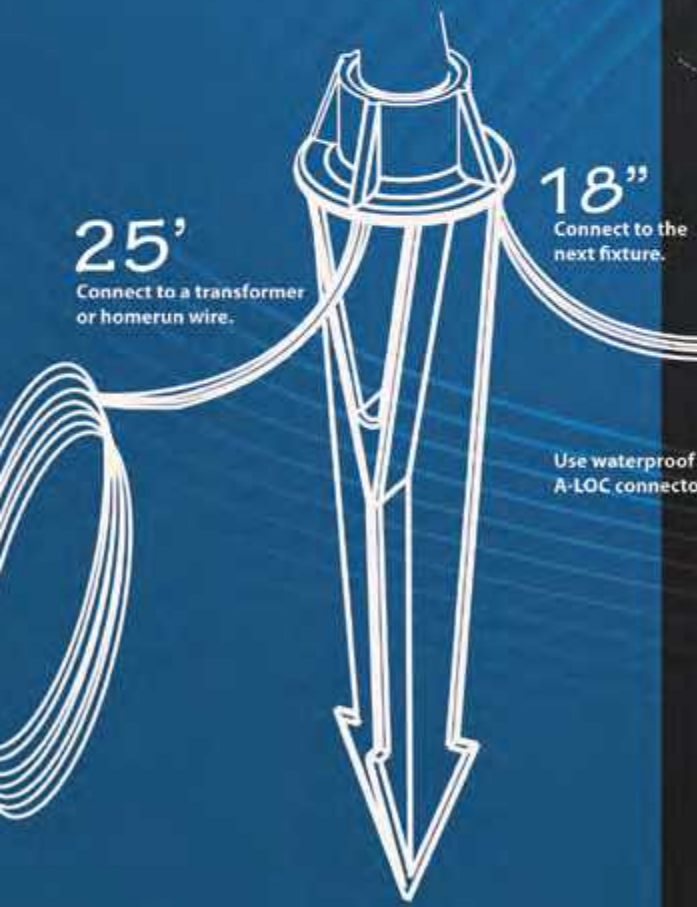

Use waterproof A-LOC connectors.

## Industry's First Double Wire Lead System

Pre-installed on most ALLIANCE in-ground fixtures.

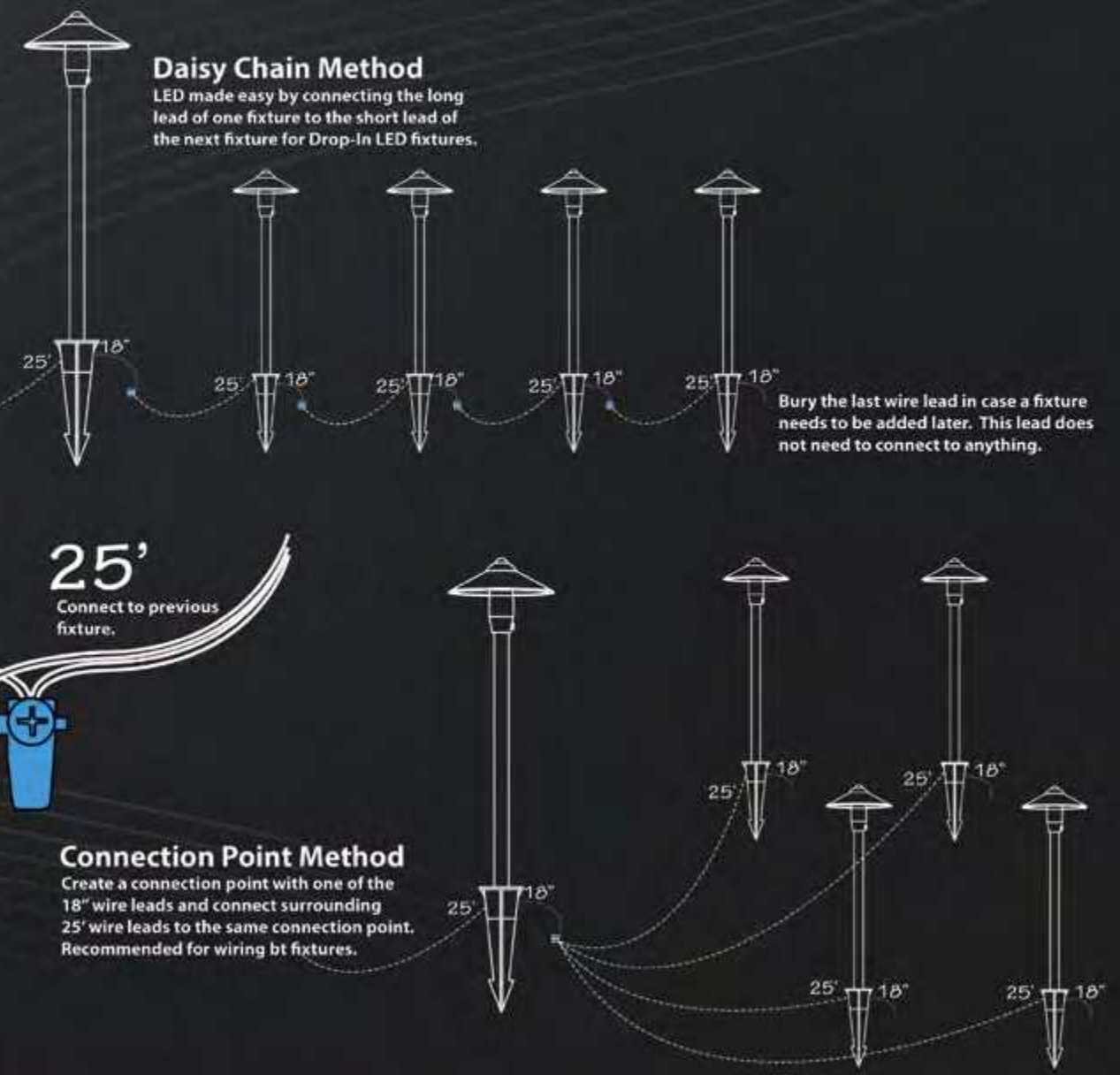

Lightbulb icon Landscape Connection  
 Instagram icon landscapeconnctcion  
 Camera icon Matt DeLong Photography  
 Instagram icon matthew\_delong\_design



### PRODUCT WARRANTY:

Alliance Outdoor Lighting warrants its products against defects in material and workmanship. Without charge, Alliance Outdoor Lighting will either repair or replace (Alliance Outdoor Lighting reserves the right to decide between repair or replacement) any properly installed Alliance Outdoor Lighting product that fails under normal operating conditions within the specified warranty period. Damage due to acts of nature, such as, but not limited to, lightning, flooding, explosions and earthquakes, are not covered.

- **Brass and Copper fixtures:** All have a lifetime warranty for all castings and housings.
- **IT Series Transformers and iTimer:** All IT series transformers carry a lifetime warranty on enclosures. All transformer windings carry a lifetime warranty.
- **XF Series Transformers:** All XF series transformers carry a lifetime warranty on enclosures. All transformer windings carry a lifetime warranty.
- **TF Series Transformers:** Two year warranty.
- **bt and Integrated LED fixtures:** All Alliance LED integrated fixtures carry a 10 year warranty.
- **bt and LED Lamps:** Ten year warranty.
- **Timers and Photocells:** Do not carry a warranty.

All products are warranted from the date of invoice, provided it is returned to the Alliance Outdoor Lighting distributor from where it is purchased. Our factory inspection determines it to be defective under the terms of the warranty. This warranty covers only equipment manufactured by Alliance Outdoor Lighting and does not extend to transportation, installation, labor compensation, or replacement charges, nor does it apply to any equipment of another manufacturer used in conjunction with Alliance Outdoor Lighting equipment.

NOTE: All Alliance Outdoor Lighting products are designed to be repaired in the field by a qualified lighting installer. All service parts are readily available and we encourage field repairs as a significant cost and labor savings which can be realized by the installer. All warranted components, as stated in the above warranty, which are installed in the field, will be honored.



### Need Help?

Contact your contractor or installer.  
 email: [techsupport@allianceoutdoorlighting.com](mailto:techsupport@allianceoutdoorlighting.com)  
 Scan the QR code to visit our online video library.  
[www.allianceoutdoorlighting.com/videolibrary](http://www.allianceoutdoorlighting.com/videolibrary)





West Coast Hub: Temecula, California  
East Coast Hub: Sanford, Florida

[www.allianceoutdoorlighting.com](http://www.allianceoutdoorlighting.com)